

**100.2410CF | 3-Hole Deck Mounted Cascade / Sheet Flow Roman Tub Filler**

**SPECIFICATIONS:**

- Solid Brass construction - includes valve
- Three Hole Installation
- Ceramic disc cartridge
- 6.1" Tub Spout Reach
- Flow Rate = 9.0 GPM @ 60 PSI

**STANDARDS:**

- ASME A112.18.1 / CSA B125.1

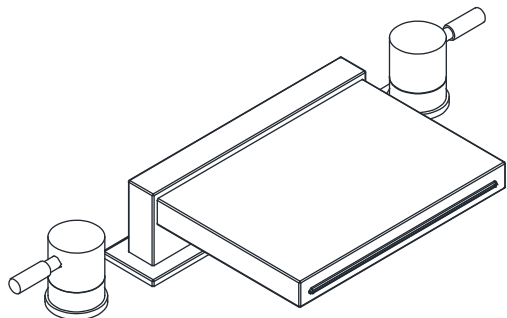

Legislation Compliance



ZeroDrip Technology



**Technical Diagram**

