

**250.1950 | Three Hole Wall Mount Faucet**

**SPECIFICATIONS:**

- Solid Brass construction - includes valve (WLM.1900)
- Three Hole Installation
- 1.2 GPM Flow Rate @ 60 PSI
- Extension Available - 250.1950E\*\*

**STANDARDS:**

- ASME A112.18.1 / CSA B125.1, NSF-61

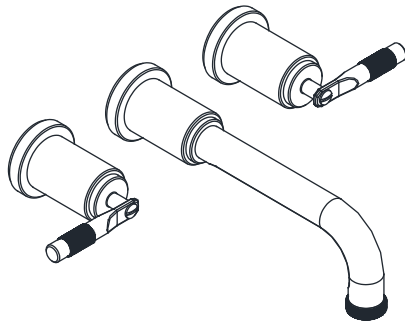

**Technical Diagram**

