

**160.3350 | Shower Set – 8" Shower Head & Hand Shower Set With Slide Bar  
– Pressure Balance Valve & Trim**

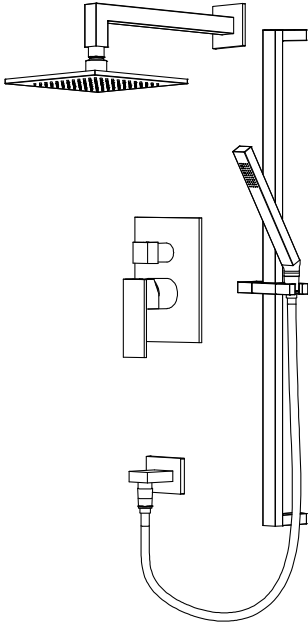

**COMPONENTS**

- HS1001SA - 12" Shower Arm
- HS1001A - 8" Shower Head
- 160.2101T - Shower Trim
- PBV.1005A - Shower Valve
- HS1006H - Hand Held
- 160.5505 - Wall Elbow
- SP.150EM - 1.5m Hose
- 160.601003A - Slide Bar

**SHOWER VALVE:**

- Pressure balance shower valve
- Valve includes service stops
- Lift bottom handle to control volume
- Turn left for hot, right for cold.
- Top handle controls water diversion
- 1/2" NPT

**SHOWER HEAD:**

- Solid brass construction
- 1.8 GPM flow rate

**HAND HELD W/ SLIDE BAR & ELBOW:**

- Solid Brass construction
- Hand held flow rate = 1.8 GPM
- 1/2" female NPT elbow connection
- With back flow prevention check valve

**STANDARDS:**

- ASME A112.18.1 / CSA B125.1

See individual component specification sheets on following pages for further details.

HS1011SA | Square Shower Arm - 400mm - 16"

SPECIFICATIONS:

- Solid Brass Shower Arm
- With Sliding Flange

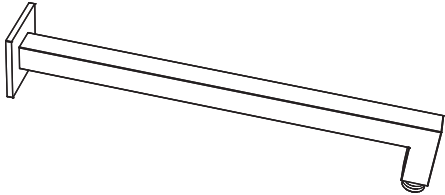

Technical Diagram

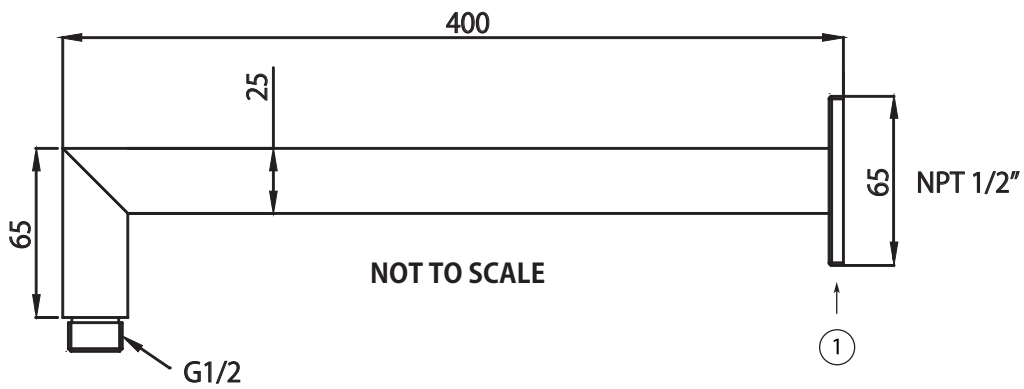

HS1001A | 8" Brass Shower Head



SPECIFICATIONS:

- Solid Brass Shower Head
- Scrub rubber nozzles to easily clean water sediment
- 1.8 GPM Flow Rate

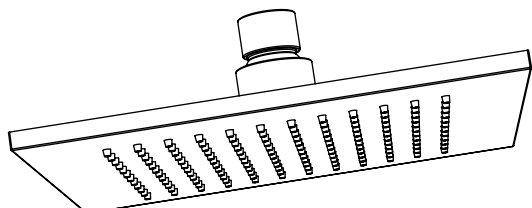

Technical Diagram

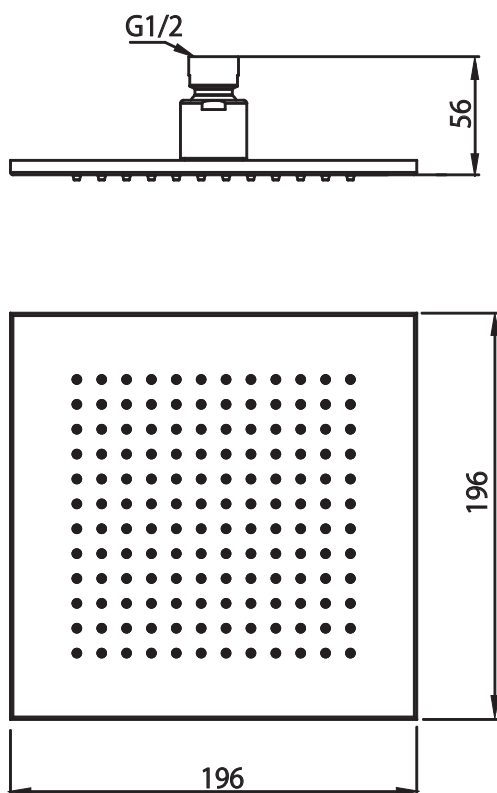

160.2101T | Tub / Shower Trim

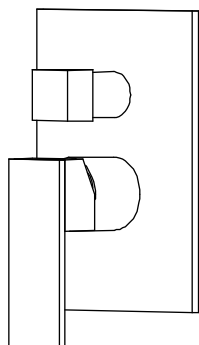

**SPECIFICATIONS:**

- Solid Brass Construction
- Valve not included - trim only
- Lift Handle to control volume. Turn left for hot, right for cold.
- Small knob controls 2-way water diversion

**Technical Diagram**

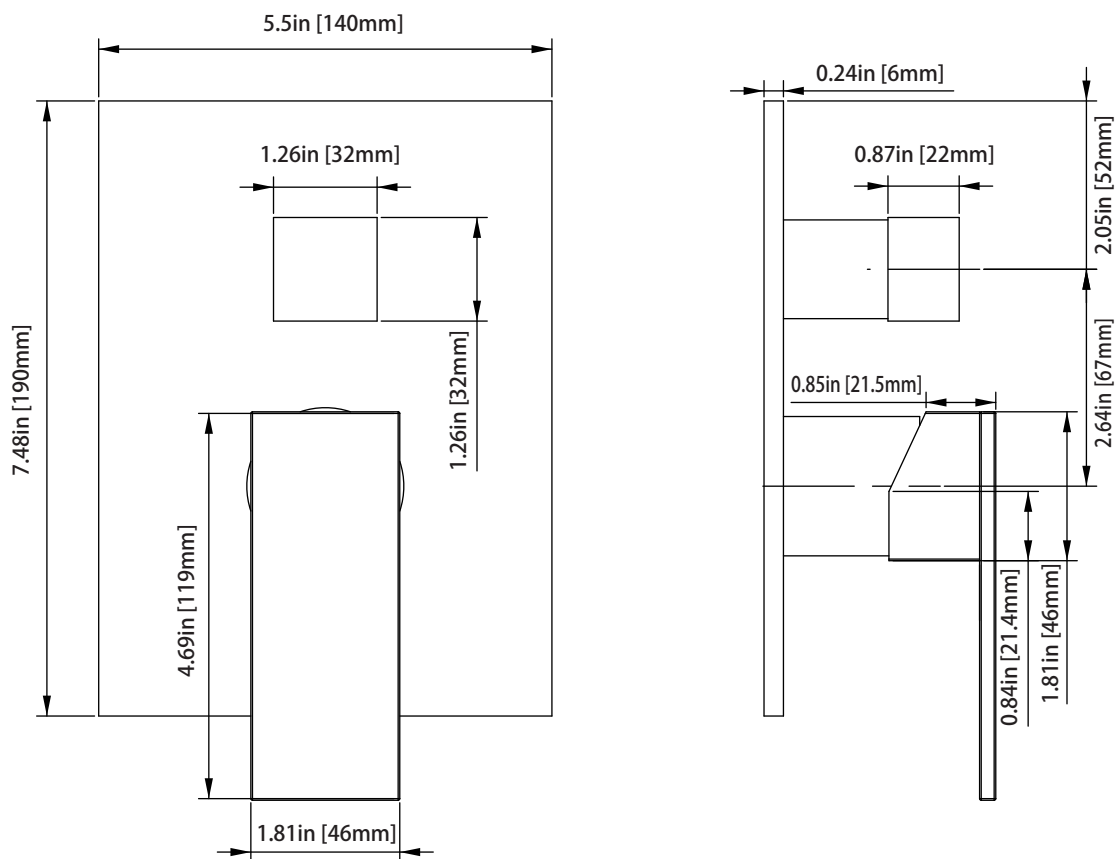

**PBV1005A | Pressure Balance Valve With Integrated 2-Way Diverter** Page 1 of 2



**SPECIFICATIONS:**

- Lift Handle to control volume. Turn left for hot, right for cold.
- Knob controls 2-way water diversion - shared output.
- Pressure Balance Valve Flow Rate - 5.5 GPM @ 60 PSI
- Extension Available - PBV.2100E\*\*

**STANDARDS:**

- ASME A112.18.1 / CSA B125.1

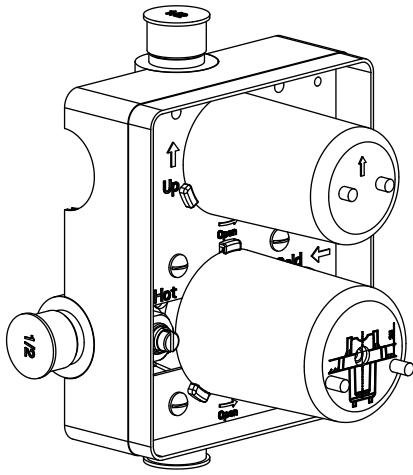

**Technical Diagram**

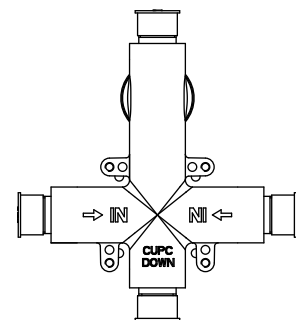
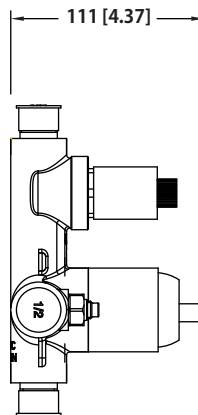
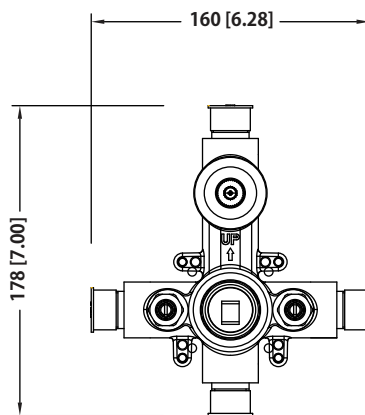
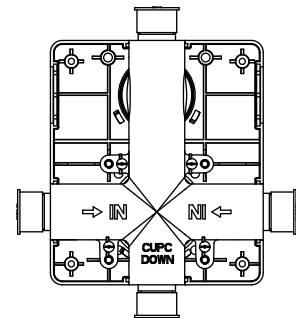
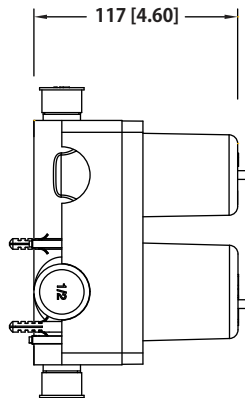
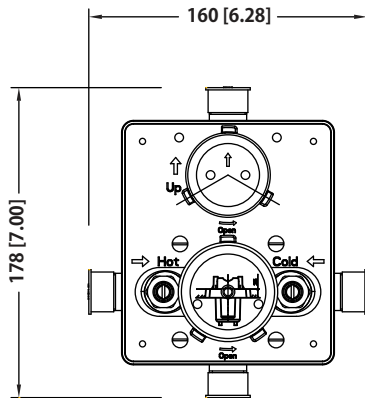



Water Diversion Diagram

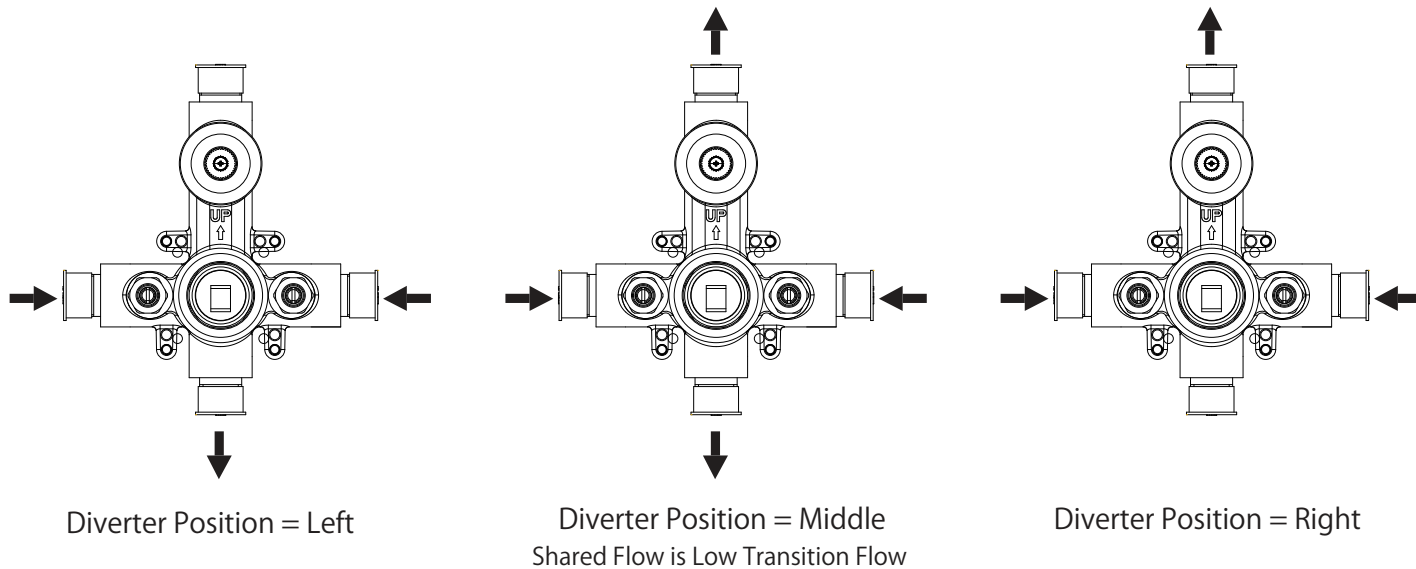

**SHS.1016 | Hand Shower Set with Slide Bar and Elbow**

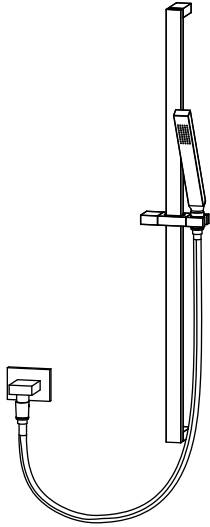

**SPECIFICATIONS:**

- Solid Brass construction with single function hand held
- 1/2" female elbow connection
- Includes check valve with back flow prevention
- 1.8 GPM flow rate

**STANDARDS:**

- ASME A112.18.1 / CSA B125.1

**Technical Diagram**

