

100.7050 | Two Output Shower W/ Rain Hand & Hand Held

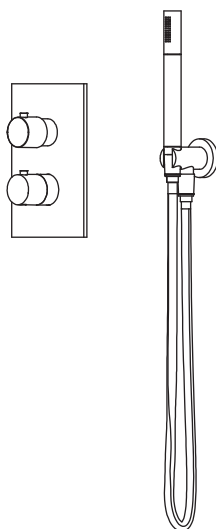

COMPONENTS

- HS1012SA - 16" Shower Arm
- HS1002A - 8" Shower Head
- 100.4000T - Shower Trim
- TVH.4420F - Shower Valve
- HS1004H - Hand Held
- HS8008 - Wall Elbow w/ Holder
- SP.150EM - 1.5m Hose

SHOWER VALVE:

- Thermostatic shower valve
- Valve includes service stops
- Turn bottom handle to set temp.
- Top handle controls water diversion
- Includes 15109 non-shared cartridge

SHOWER HEAD:

- Solid brass construction
- 1.8 GPM flow rate

HAND HELD:

- Solid Brass construction
- 1.8 GPM flow rate
- 1/2" female NPT connection
- With back flow prevention check valve

STANDARDS:

- ASME A112.18.1 / CSA B125.1

See individual component specification sheets on following pages for further details.

HS1012SA | Round Shower Arm - 400mm - 16"

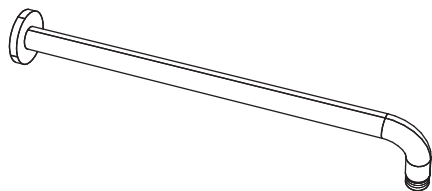

SPECIFICATIONS:

- Solid Brass Shower Arm
- With Sliding Flange

FAST SHIP FINISHES :

- Chrome - HS1012SACP / Brushed Nickel - HS1012SABN

Technical Diagram

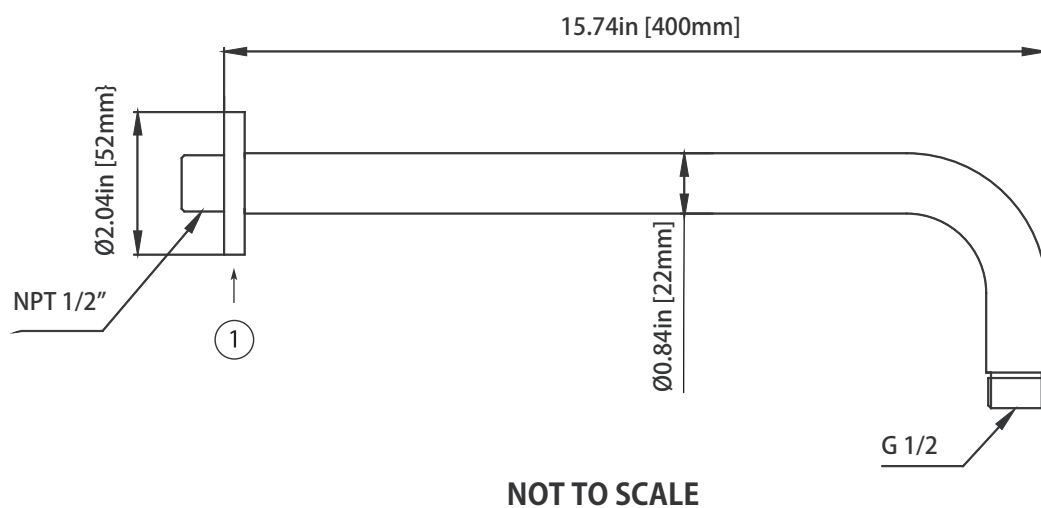

Part Number Guide:

- ① Flange - HS1002SA-1253CP - Chrome
HS1002SA-1253BN - Brushed Nickel

HS1002A | 8" Brass Shower Head

SPECIFICATIONS:

- Solid Brass Shower Head
- Scrub rubber nozzles to easily clean water sediment
- 1.8 GPM Flow Rate

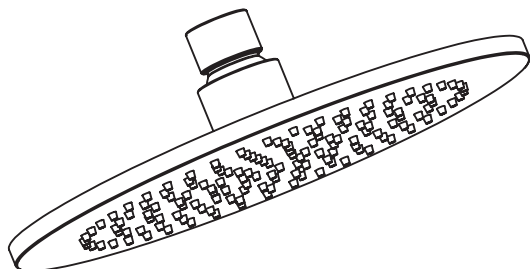

Technical Diagram

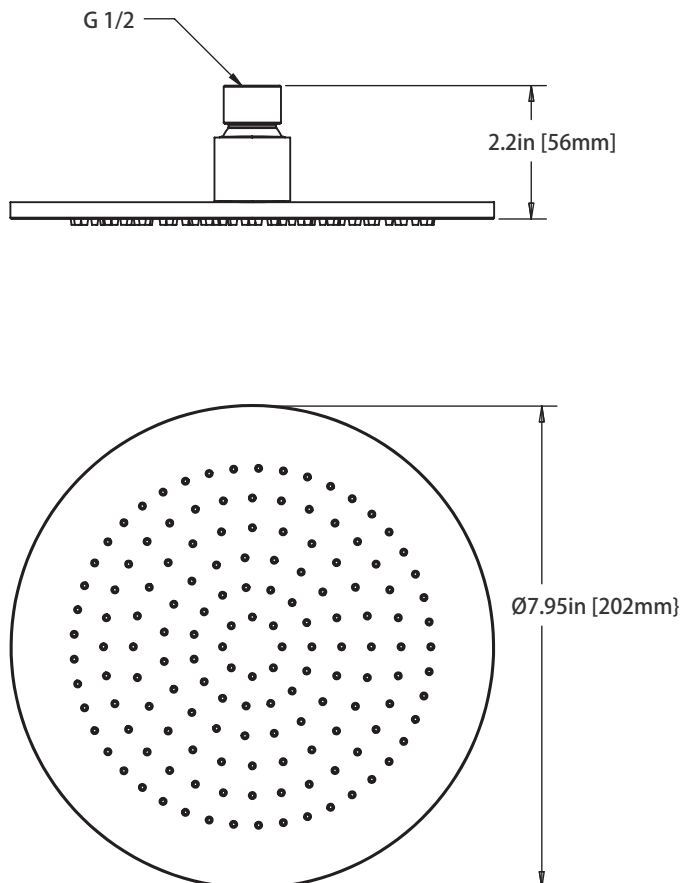

100.4000T | Thermostatic Shower Trim

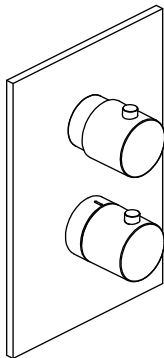

SPECIFICATIONS:

- Solid Brass construction
- Valve not included - trim only
- Turn bottom handle to control temperature.
- Turn top handle to divert water & control volume

Technical Diagram

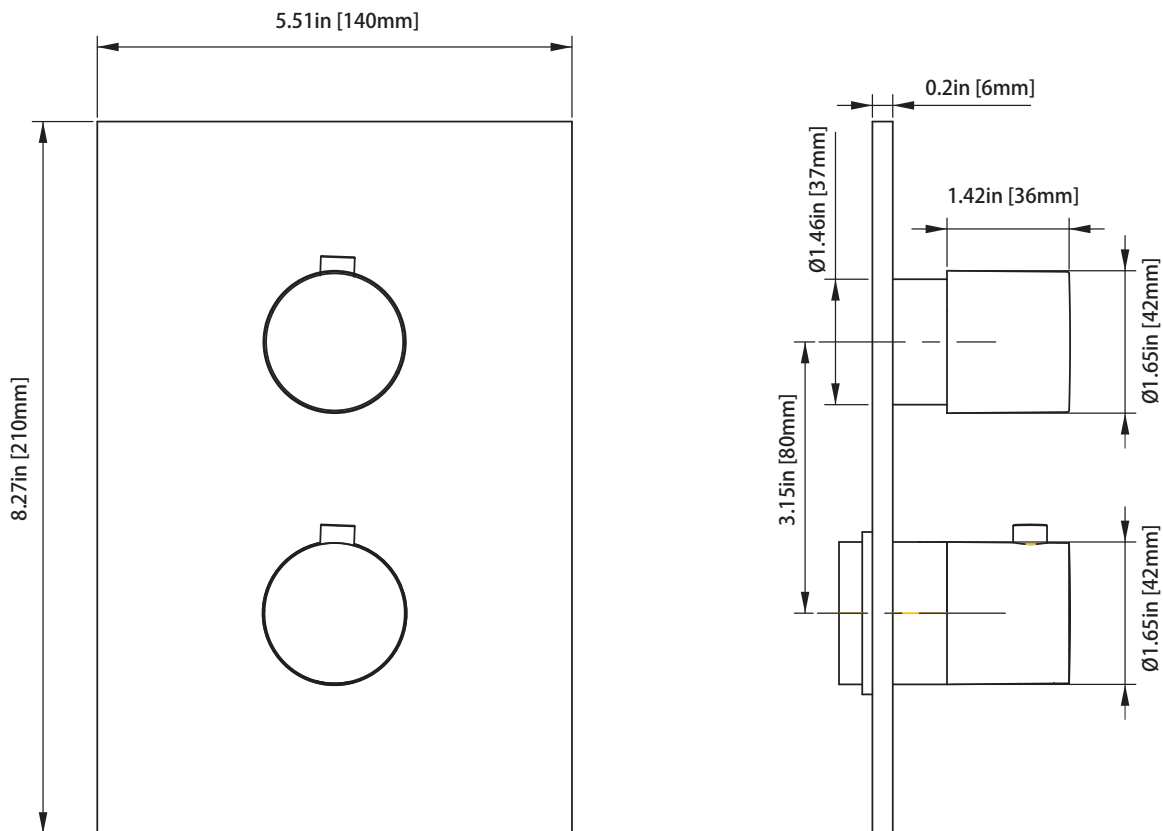

TVH.4420F | 3/4" Thermostatic Valve With 2-Way Diverter & Integrated Volume Control Page 2 of 2

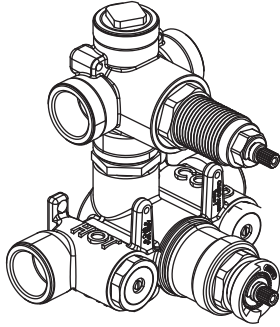

SPECIFICATIONS:

- Turn bottom knob to control temperature.
- Turn top knob to control water flow.
- Thermostatic Valve Flow Rate - 8.0 GPM @ 60 PSI
- Extension Available - TVH.4101E**

STANDARDS:

- ASME A112.18.1 / CSA B125.1

! A separate volume control is **not** needed to turn water supply off. Volume control functionality is integrated within this valve.

Technical Diagram

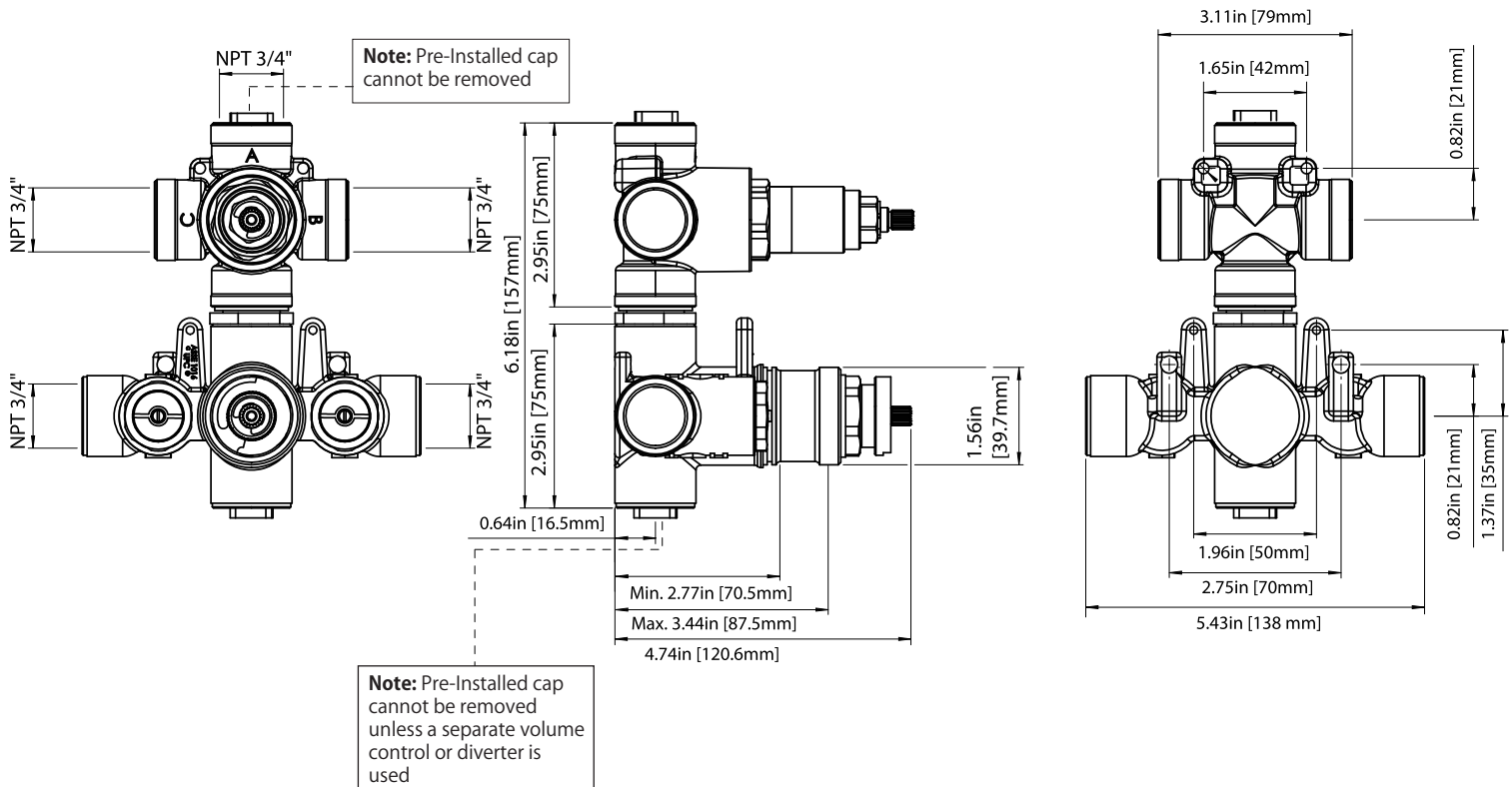

TVH.4420F | 3/4" Thermostatic Valve With 2-Way Diverter & Integrated Volume Control Page 2 of 2



TWO OUTPUT - CAL-GREEN - NO SHARED PORT OPERATION

Diverter Cartridge # - **15109** (Included)

Total 3 Positions as defined below, with **only** 1 port active at one time.

- Position 0 - Off - No Water Flow
- Position 1 - Output B Activated
- Position 2 - Output C Activated

TWO OUTPUT - SHARED PORT OPERATION

Diverter Cartridge # - **15103** (Not Included)

Total 4 Positions as defined below, with 2 ports active at one time.

- Position 0 - Off - No Water Flow
- Position 1 - Output B Activated
- Position 2 - Output B+C Activated
- Position 3 - Output C Activated

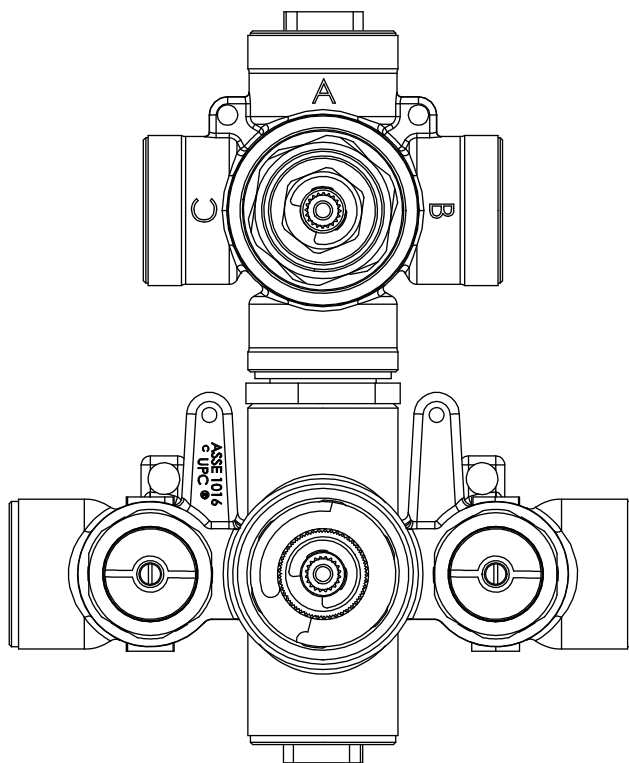

Water Diversion Diagram

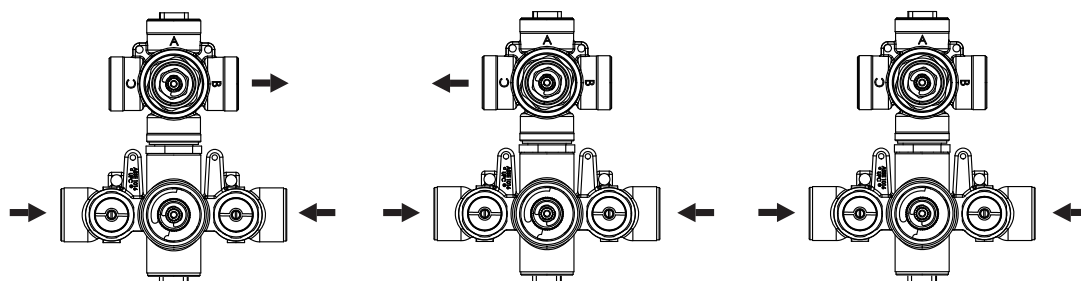

Diverter Position = 1

Diverter Position = 2

Diverter Position = off

HS1004H | Solid Brass Hand Shower

SPECIFICATIONS:

- Solid Brass Construction
- 1.8 GPM Flow Rate
- With back flow prevention check valve



Technical Diagram

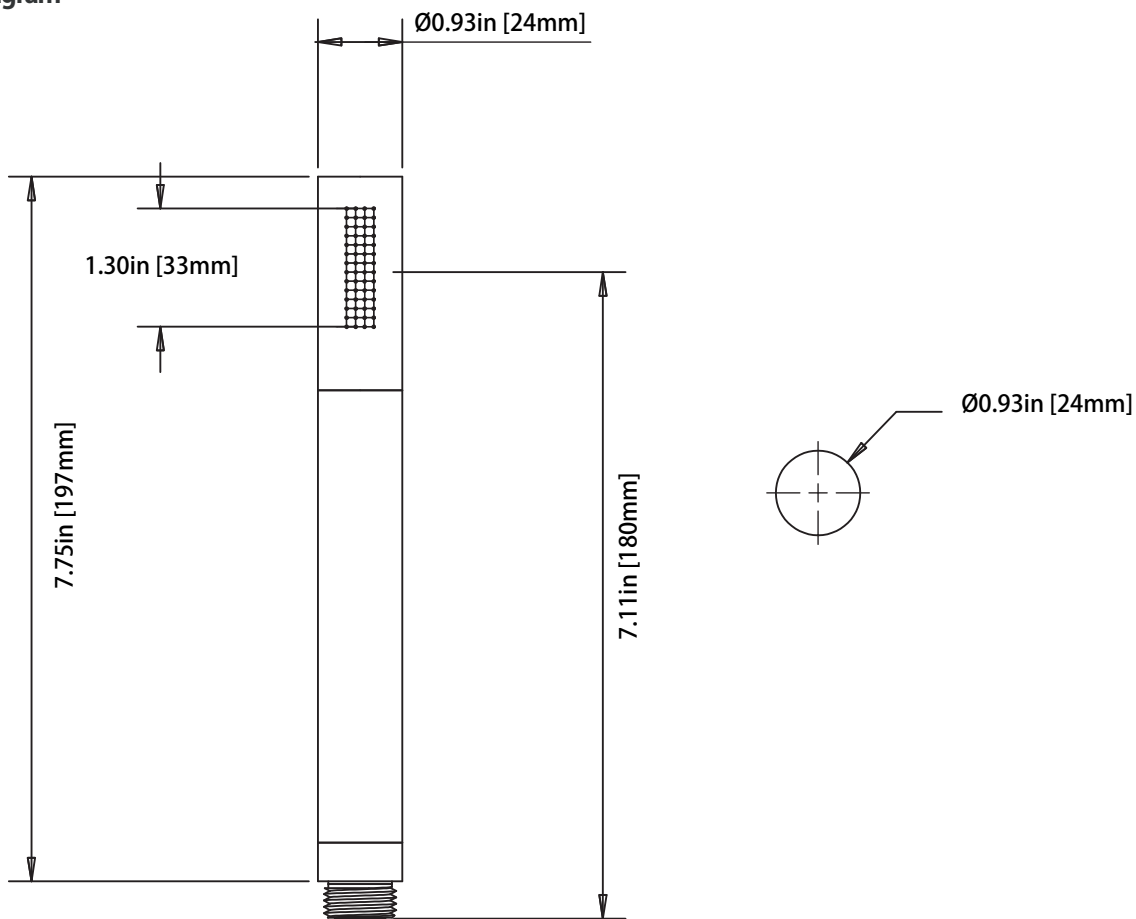

HS8008 | Wall Elbow With Holder Combo

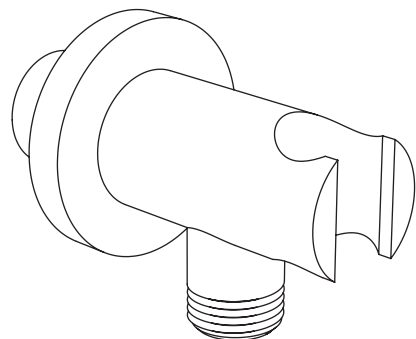

SPECIFICATIONS:

- Solid Brass construction
- Includes check valve with back flow prevention.

FAST SHIP FINISHES :

- Chrome - HS8008CP / Brushed Nickel - HS8008BN

Technical Diagram

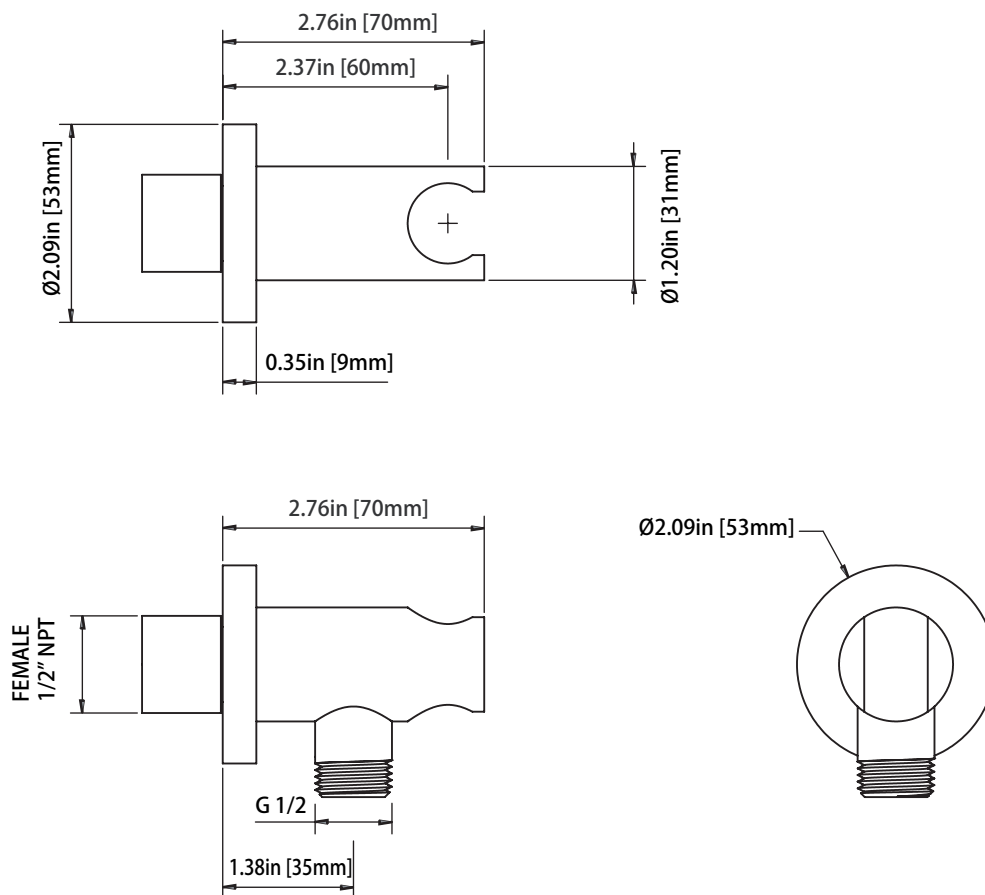

SP.150EM | Easy Maneuver Hose



SPECIFICATIONS:

- Stainless steel construction
- G-1/2" connection
- 1.5m length

Technical Diagram

