

100.1400 | Kitchen / Bar Faucet

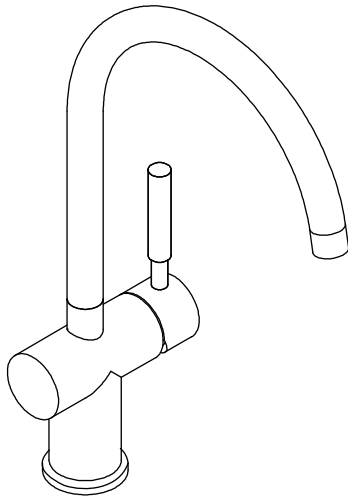

SPECIFICATIONS:

- Solid Brass construction
- Single Hole Installation
- 1.8 GPM Flow Rate @ 60 PSI
- Ceramic disc cartridge allows both volume and temperature control

STANDARDS:

- ASME A112.18.1 / CSA B125.1, NSF-61 & EPA Watersense

FLOW
Efficient

Technical Diagram

