

100.1300 | Single Hole Bidet Faucet

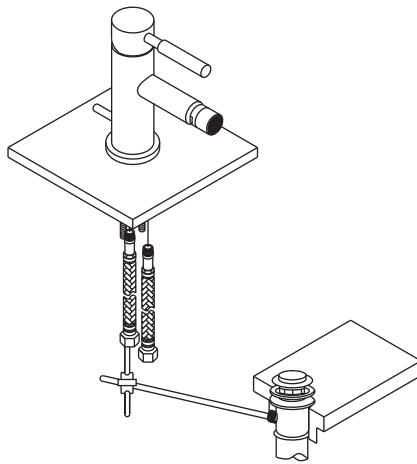

SPECIFICATIONS:

- Solid Brass construction
- Drain Included

STANDARDS:

- ASME A112.18.1 / CSA B125.1, NSF-61

FLOW
Efficient

Technical Diagram

