

# Product Parts Breakdown

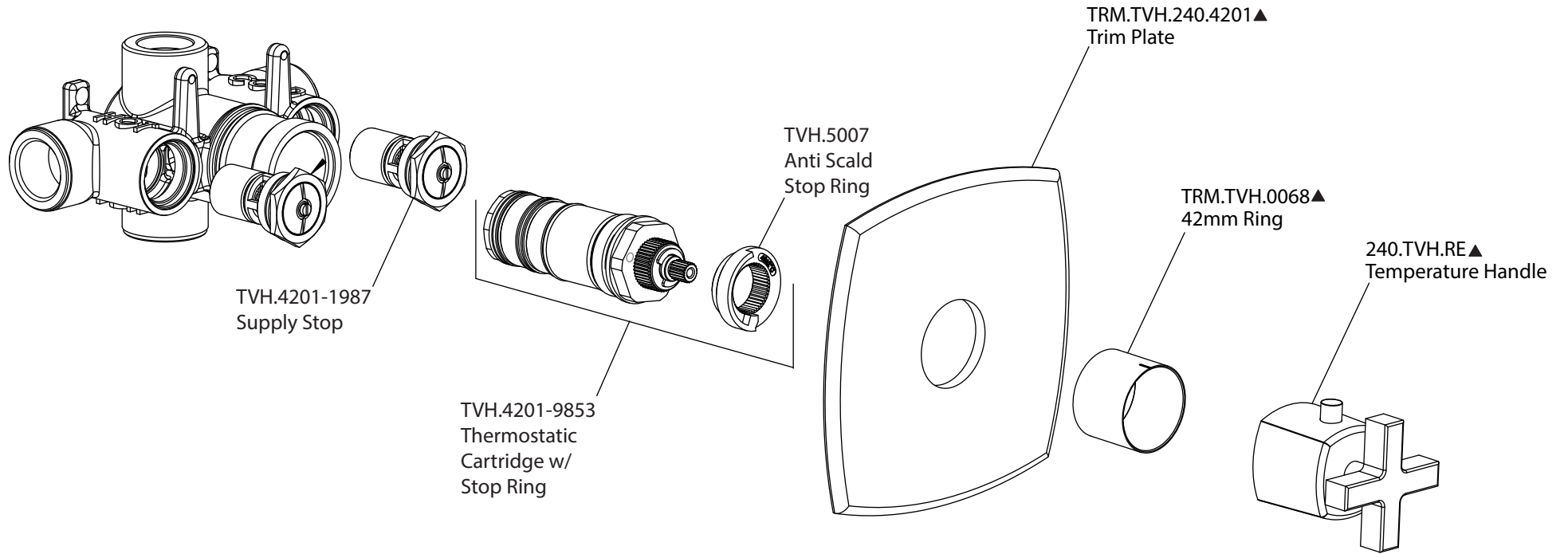

**Model No. 240.4201**

**Ver 2.53**