

Product Parts Breakdown

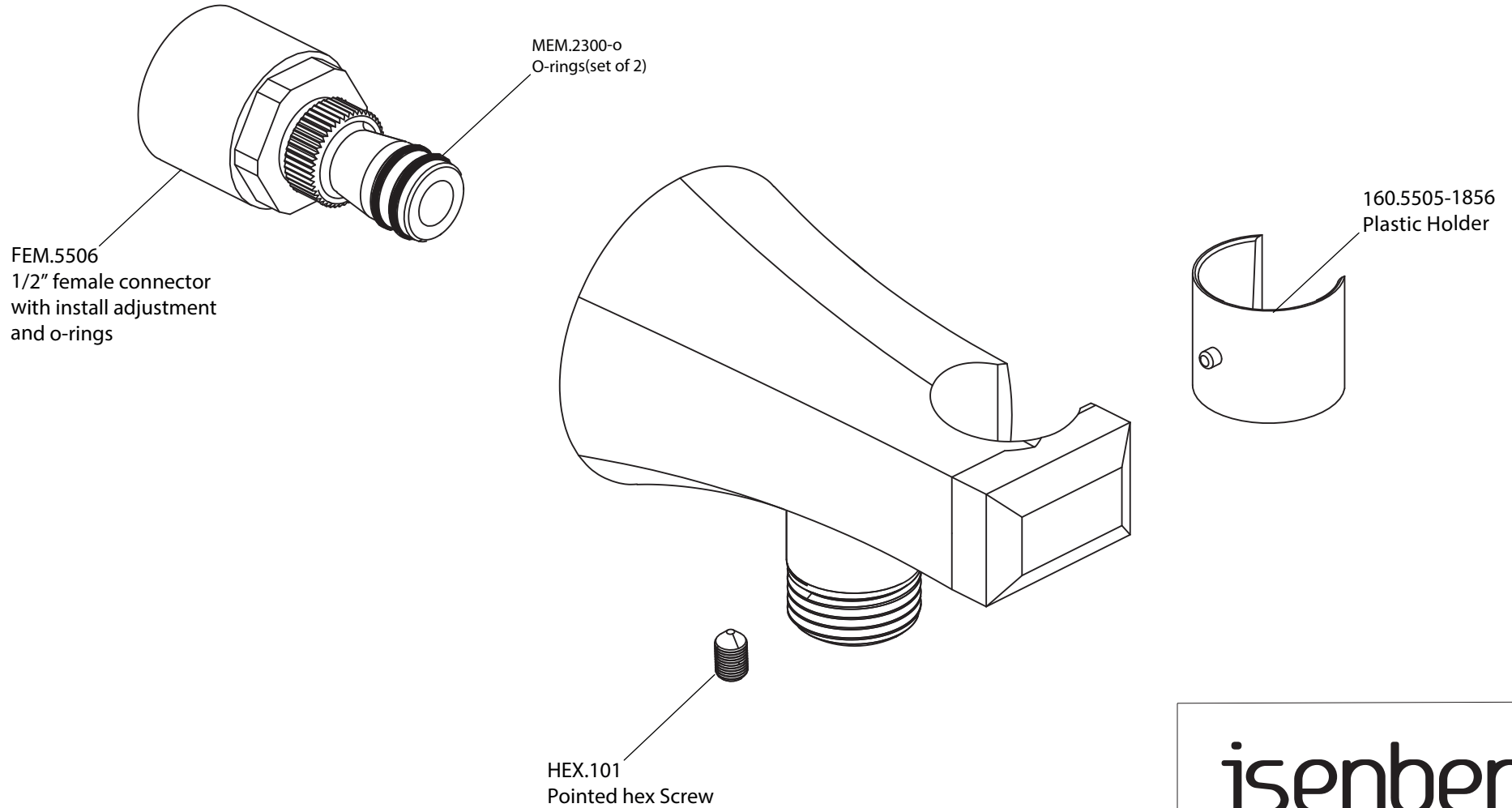

isenberg
innovation+design

230.8006

Ver 2.55