

# Product Parts Breakdown

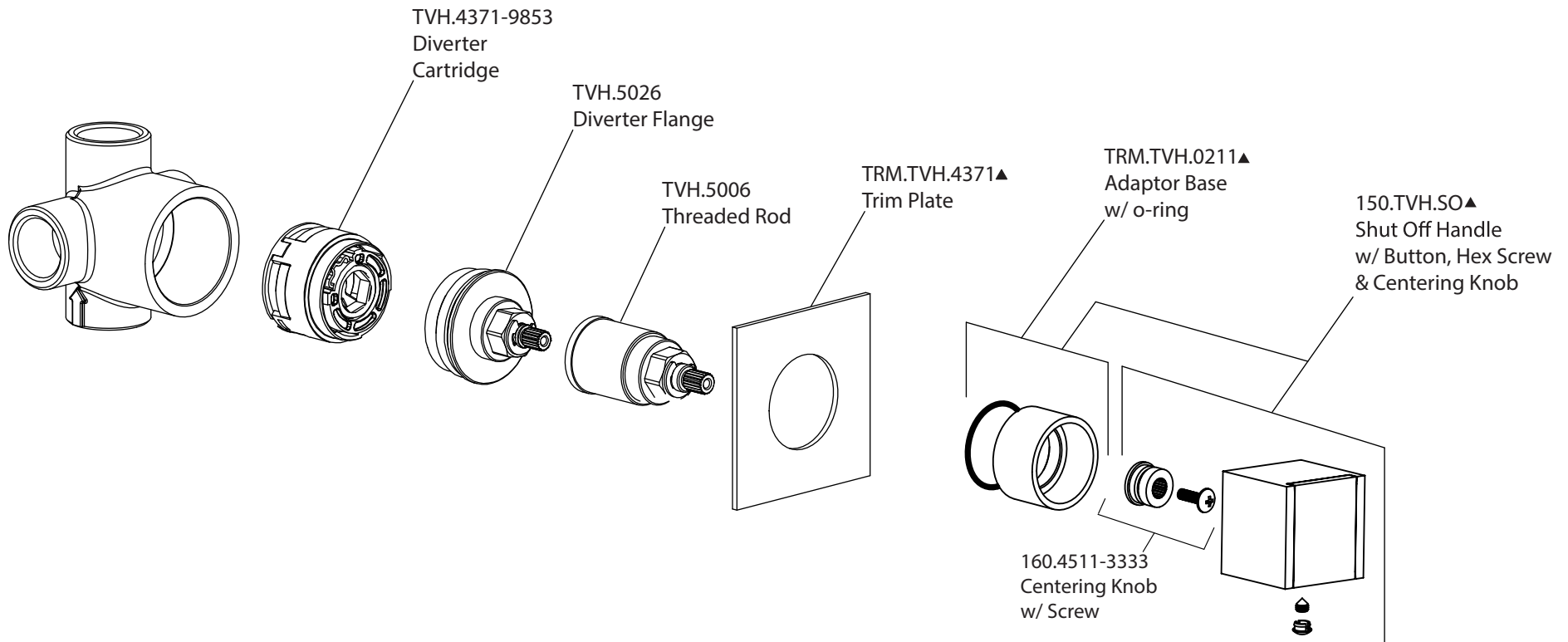

**Model No.** 150.4371

**Ver** 2.54