

Product Parts Breakdown

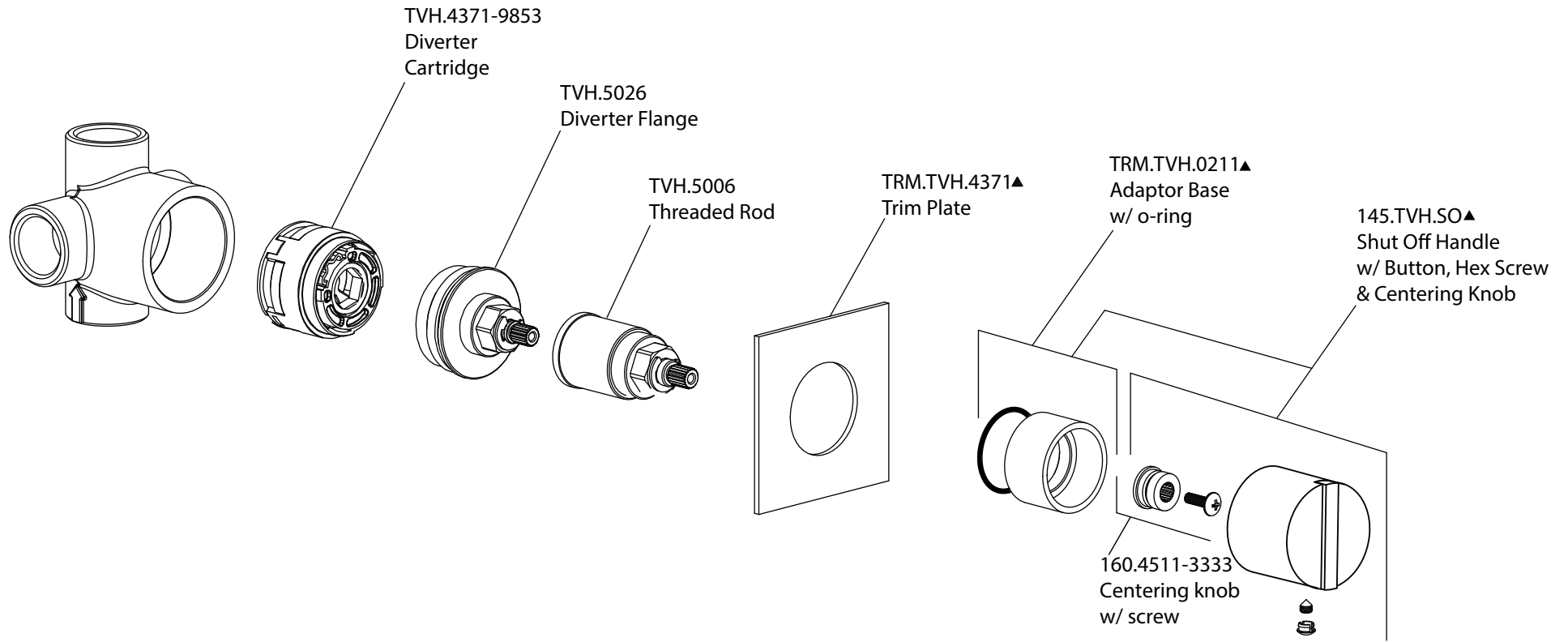

Model No. 145.4371

Ver 2.54