

Product Parts Breakdown

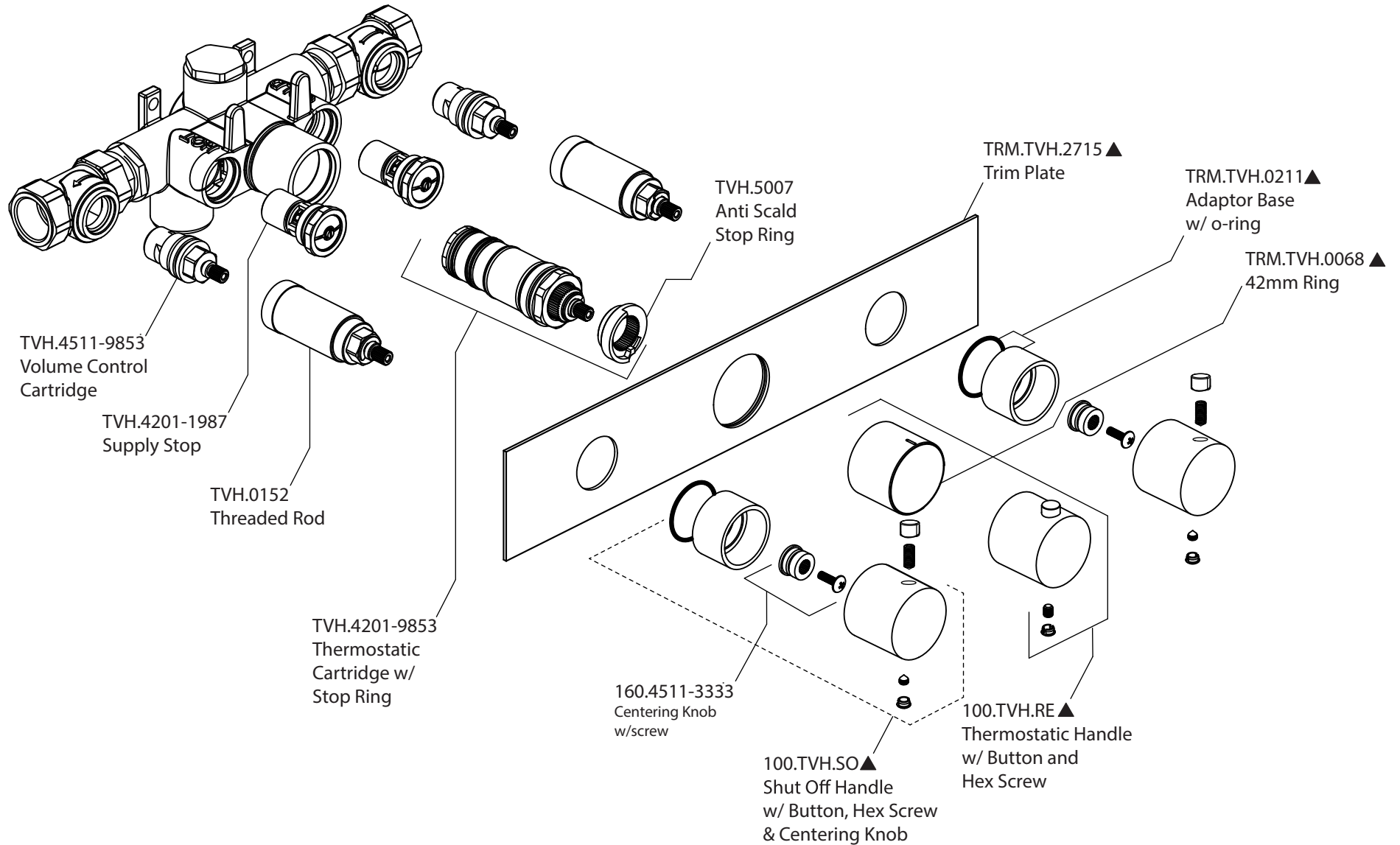

Model No. 100.2715

Ver 2.58