

Product Parts Breakdown

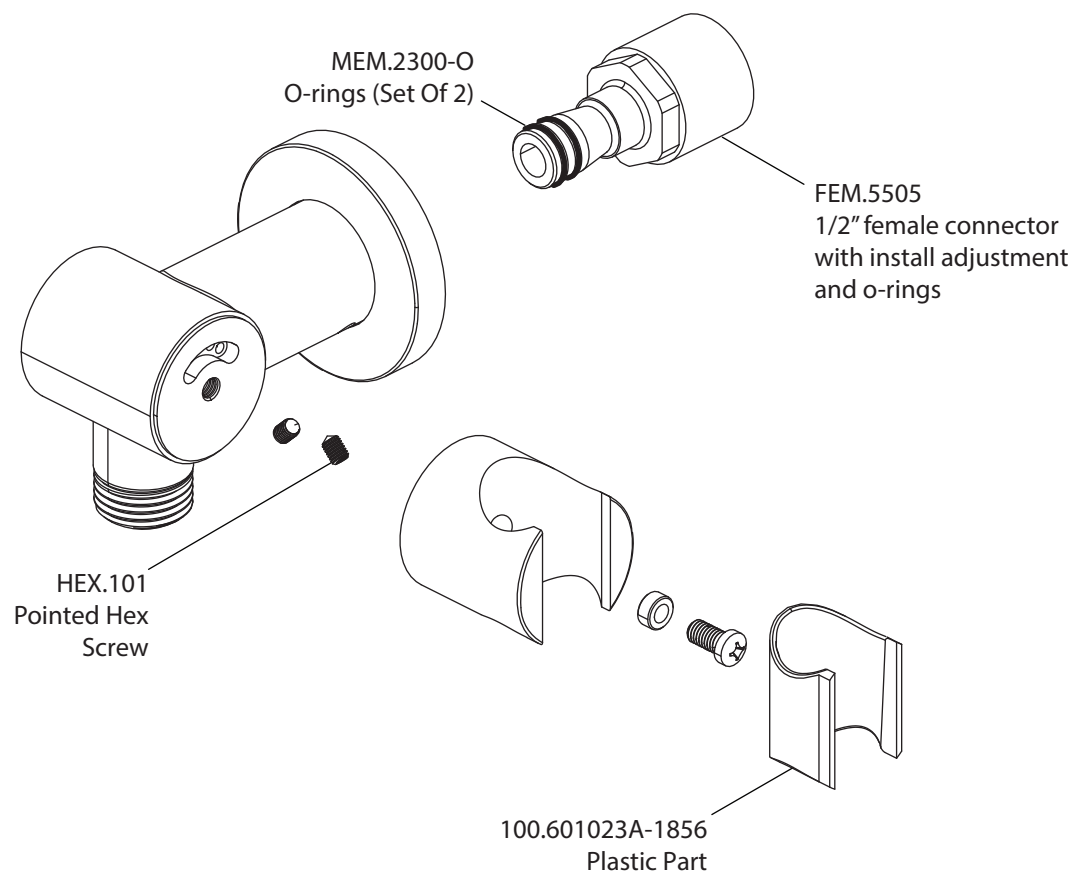

isenberg
innovation+design

HS8027

Ver 2.55