

Product Parts Breakdown

▲ Specify Finish

HS1070-9856 ▲
Shower Arm w/o Flange

HS1070-9857 ▲
Flange

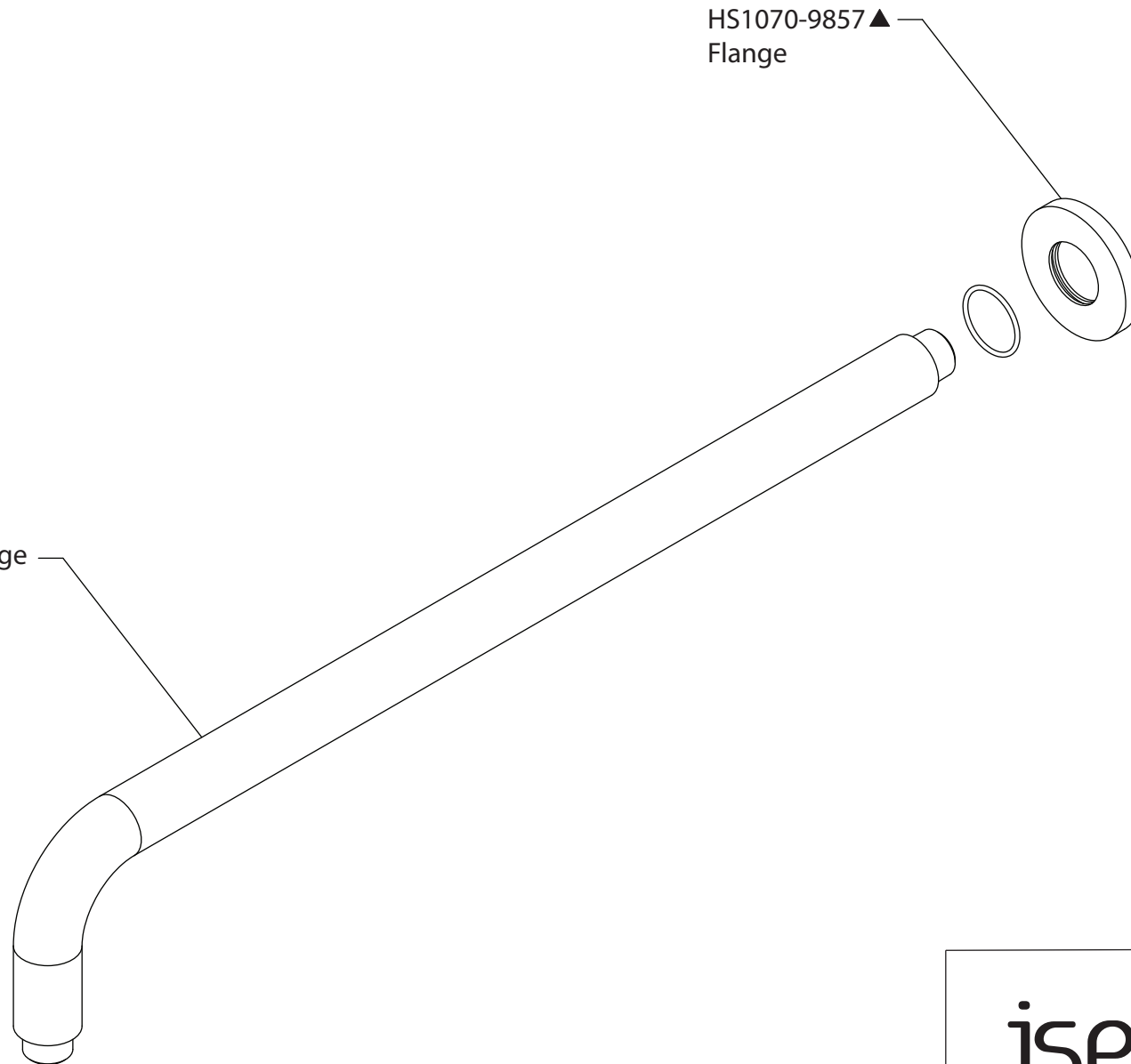

isenberg
innovation+design

HS1070

Ver 2.53