

Product Parts Breakdown

▲ Specify Finish

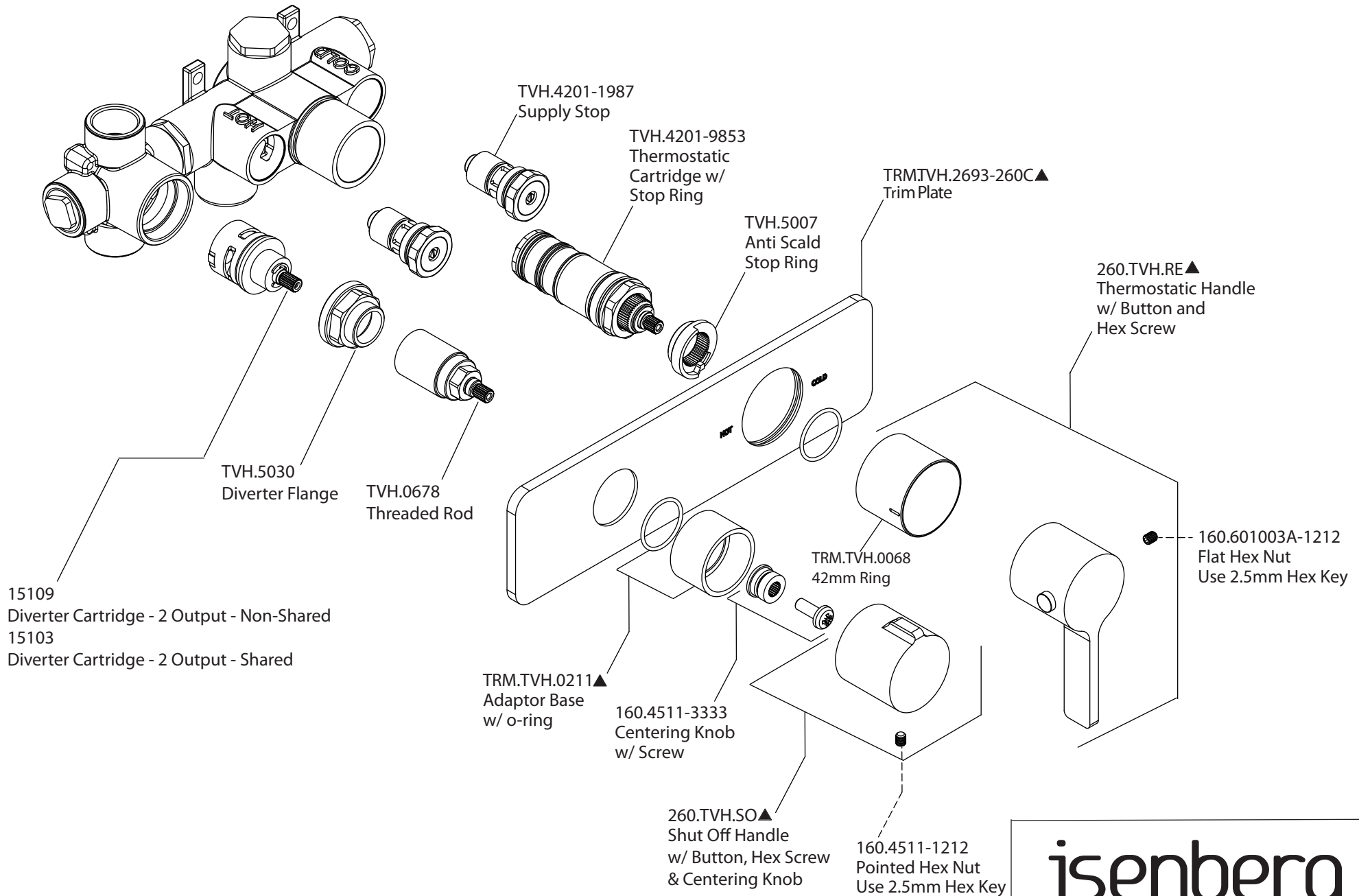

isenberg
innovation+design

260.2717

Ver 2.53