

Product Parts Breakdown

▲ Specify Finish

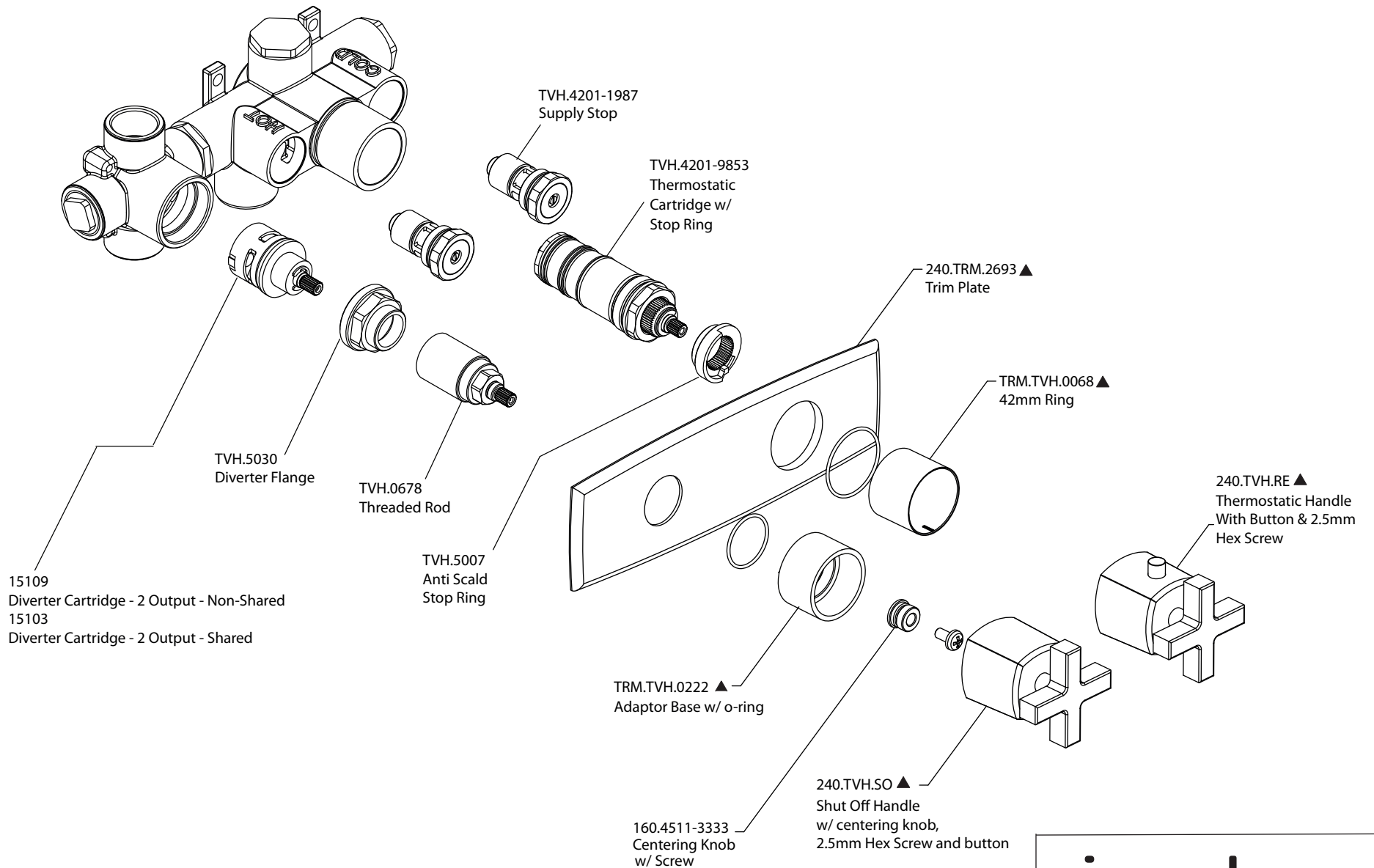

isenberg
innovation+design

240.2717

Ver 2.53