

Product Parts Breakdown

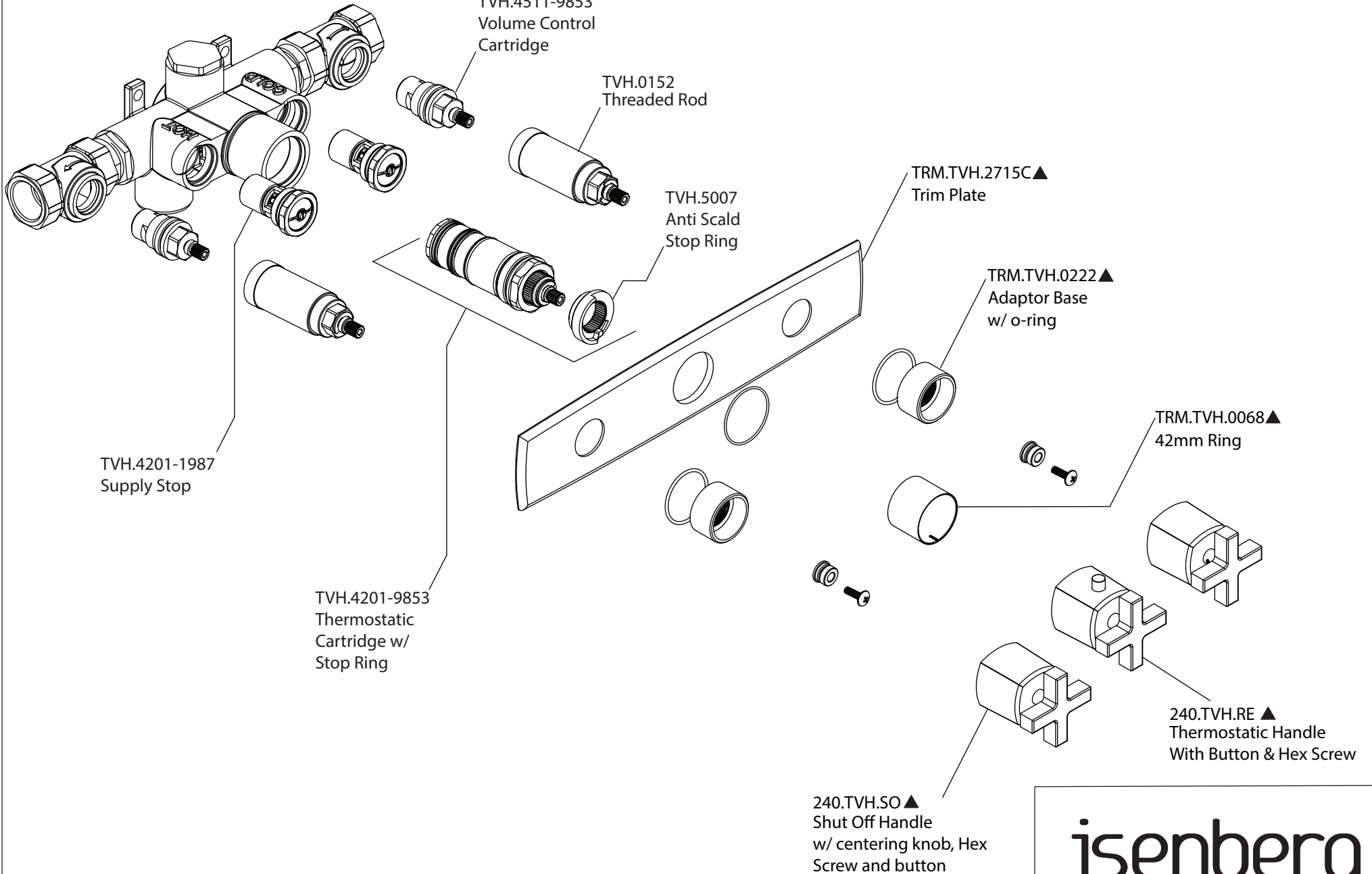

isenberg
innovation+design

240.2715