

Product Parts Breakdown Using TVH.4420F Valve

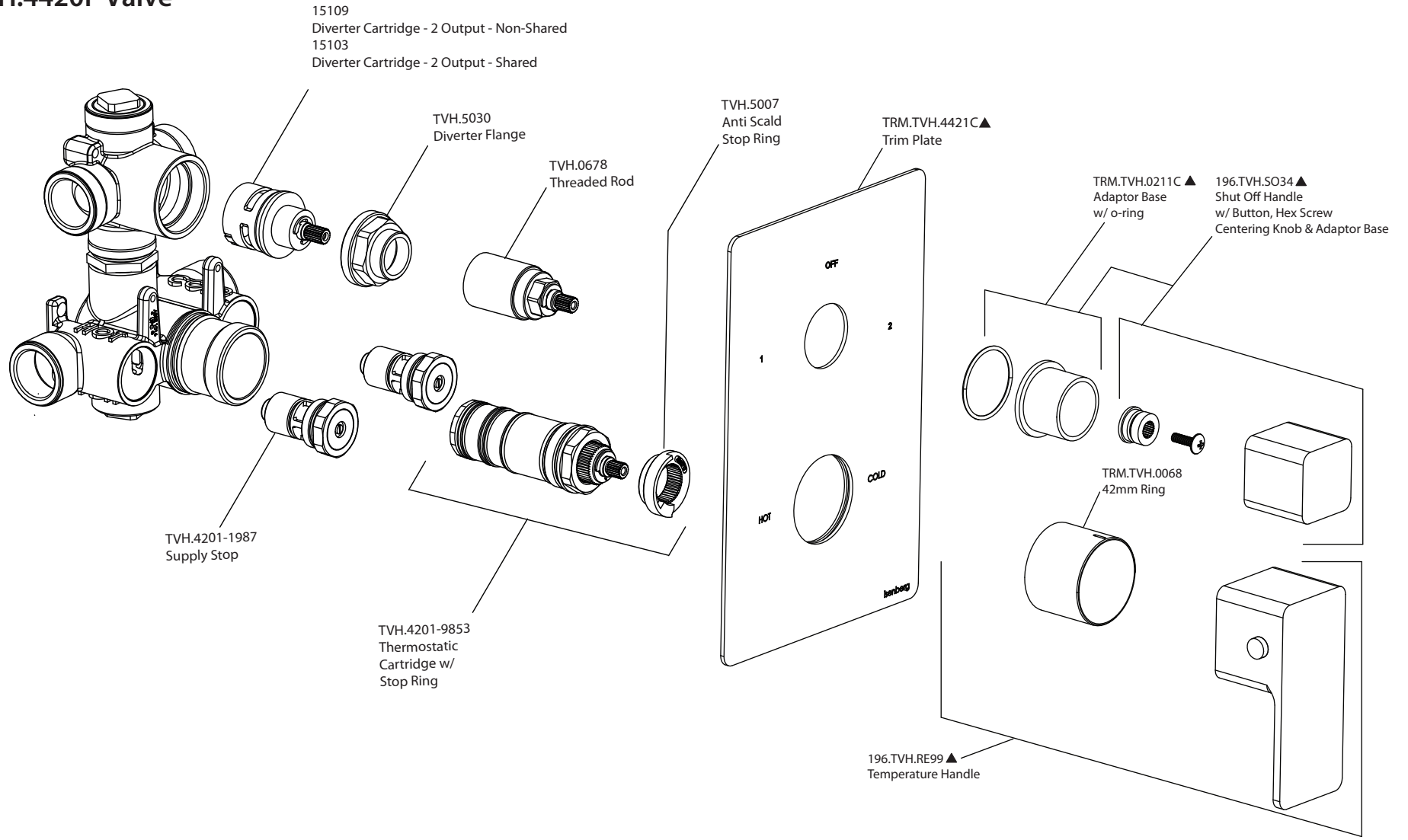

isenberg
innovation+design

196.4422

Product Parts Breakdown Using TVH.4420 Valve

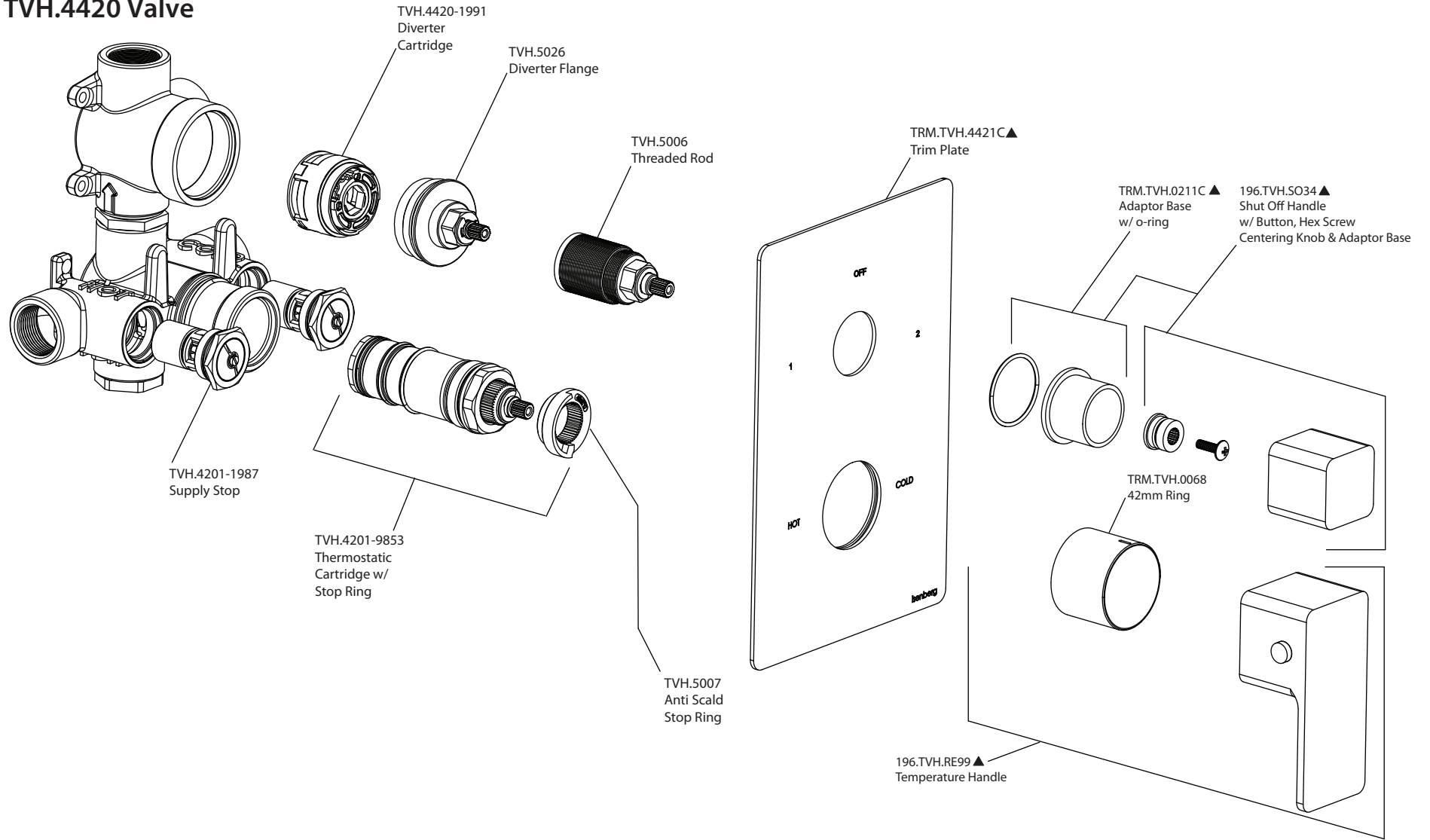

isenberg
innovation+design

196.4422