

Product Parts Breakdown Using TVH.4301F Valve

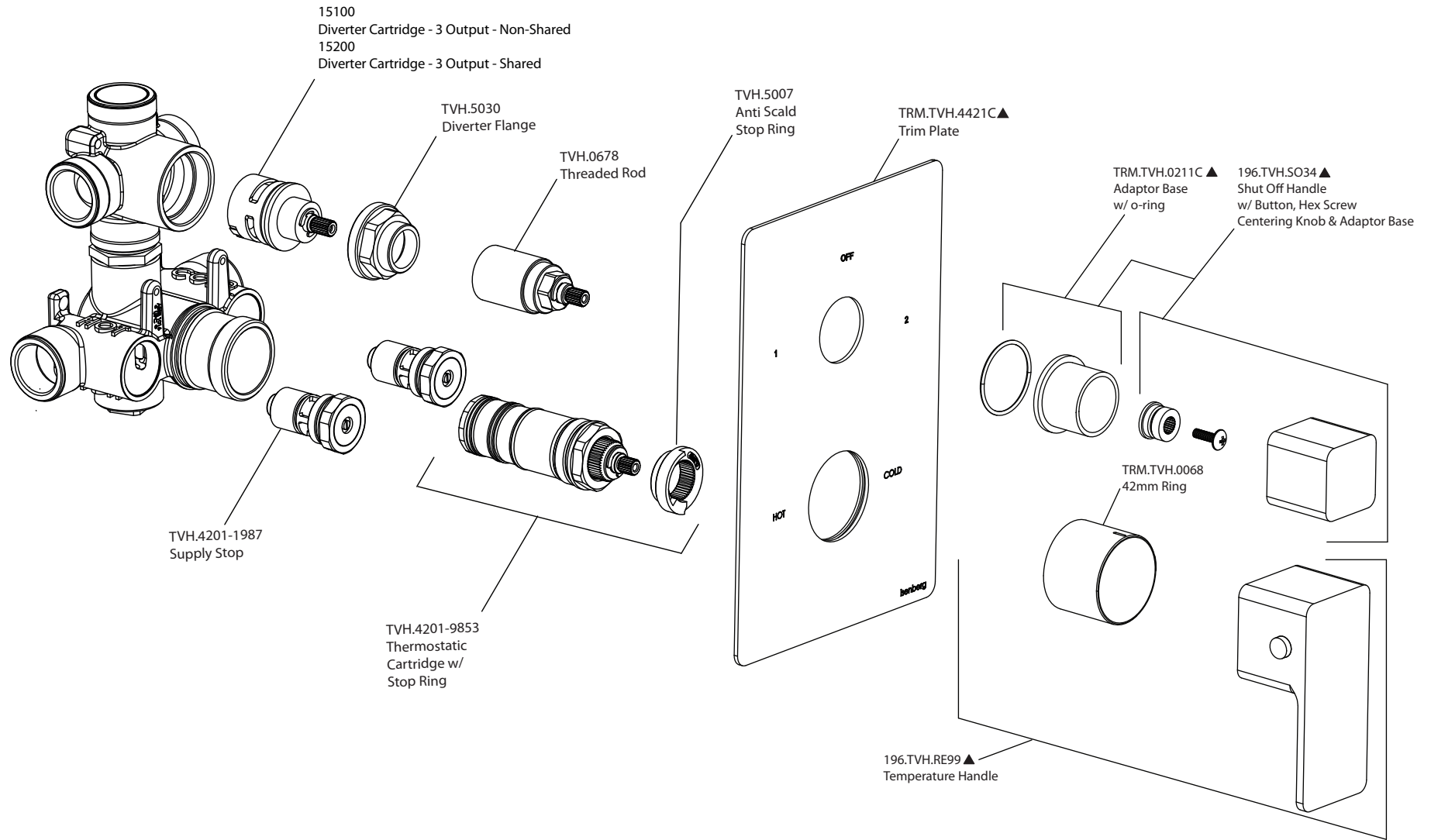

isenberg
innovation+design

196.4302

Product Parts Breakdown Using TVH.4301 Valve

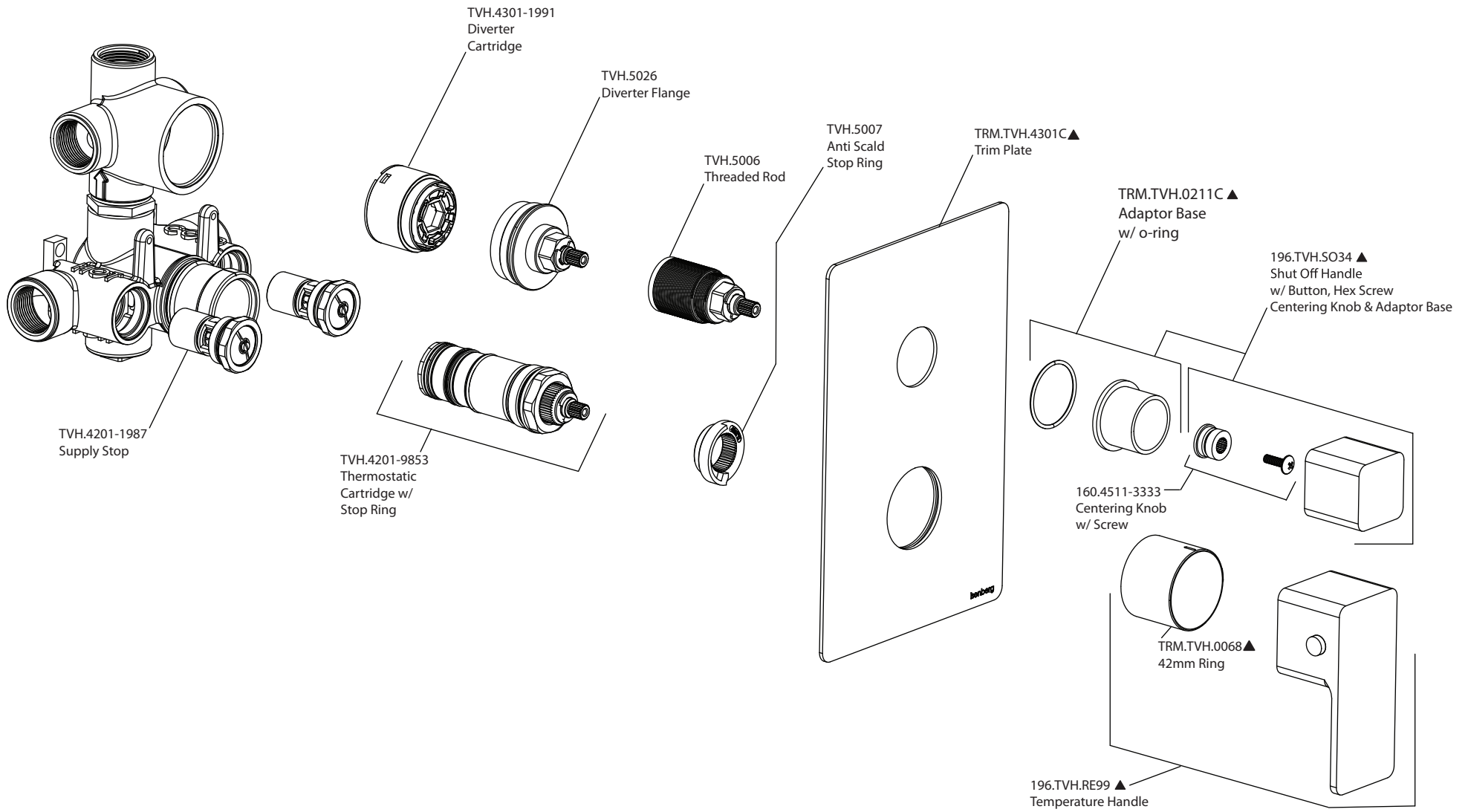

isenberg
innovation+design

196.4302